

Slide Clamb 4.0

Glassicherungsstift

- Zur sicheren Fixierung des VSG-Türblatts an der Klemmbacke

MONTAGEANLEITUNG

Slide Clamb 4.0 VSG-Glasklemmbacke

i Abstände und Maße

mit 65 kg Beschlag

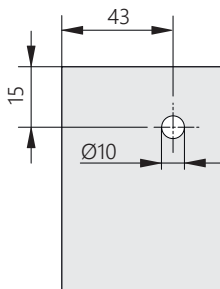

mit 120 kg Beschlag



mit 65 kg Laufwagen

2x



mit 120 kg Laufwagen

4x



MONTAGEANLEITUNG

Slide Clamb 4.0 VSG-Glasklemmbacke

1 mit 65 kg Laufwagen

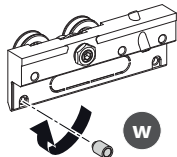

mit 120 kg Laufwagen

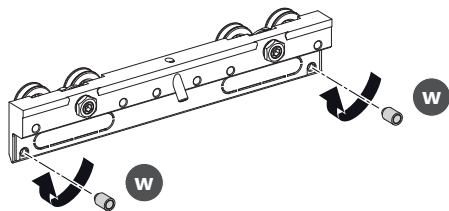

2 mit 65 kg Laufwagen

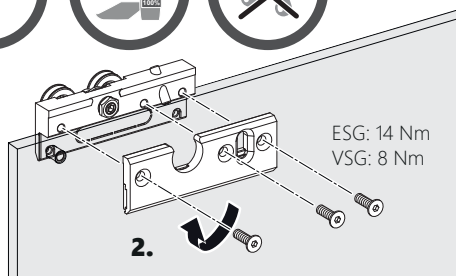
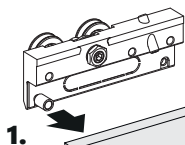

mit 120 kg Laufwagen

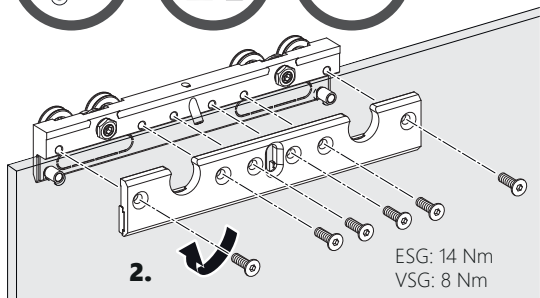
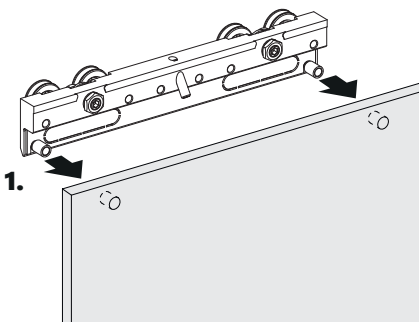

MONTAGEANLEITUNG

Slide Clamb 4.0 VSG-Glasklemmbacke